

January 2019
VOL. 71 NO. 1

OFFICIAL PUBLICATION OF SME

Mining

engineering



**Virtual instrumentation at Haile Mine
Pumps for mine backfilling
Cat adds to its mining line**



SPECIAL INSERT: ACE *PreShowguide* 2019



me.smenet.org

Real-world improvement through virtual instrumentation at OceanaGold Haile

by Brett Schug, Caelen Anderson, Carlos Cristoffanini and Sohail Nazari



The processing plant at the Haile gold mine recently saw improvement through automation.

The Haile gold mine in South Carolina is increasing the automation level of its processing plant in order to improve operational stability. One step toward this goal is the application of a digital twin concept to provide virtual instruments. Haile has engaged Andritz to implement virtual instruments at its grinding area hydrocyclones and at its tailing thickener underflow pump. These virtual instruments provide density values in a traditionally difficult location for reliable slurry density measurement. The digital twin is a first-principles integrated design engineering with advanced simulation (IDEAS) simulation model, connected in real time to the control system. Results have been promising, with the virtual instrument values matching the physical instrument under normal operating conditions

and showing better prediction under upset conditions. Haile plans to use the virtual instruments as optional process control parameters.

OceanaGold's Haile gold mine is located near Kershaw, SC, about 80 km (50 miles) southeast of Charlotte, NC. This location was first mined in 1827 and

has produced gold through several operating periods since then, including a heap leaching operation from 1985 through 1992. In October 2015, OceanaGold acquired Romarco Minerals, the previous owner of the Haile operation.

The current operation began in 2017 as an openpit mine with additional underground resources. The nameplate throughput is 5,760 t/d (6,350 stpd) ore, and 2017 production was 3,345 kg (118,000 oz) gold, with 3,968 to 4,384 kg (140,000 to 155,000 oz) gold expected in 2018. Proven and probable reserves exceed 85 t (3 million oz) gold. The process, as shown in Fig. 1, includes a primary jaw crusher, comminution with a semiautogenous grinding (SAG) mill and ball mill circuit, flash flotation, rougher flotation, regrinding, pre-aeration, carbon-in-leach leaching, carbon elution and regeneration, cyanide recovery, electrowinning and refining. The Haile operation's inaugural gold pour took place Jan. 20, 2017. Mine life is expected through the year 2030.

Based partially on the prior experience of some key OceanaGold personnel with automation services from Andritz on other projects, OceanaGold decided to include Andritz on the Haile project. The scope of these services for Haile included design and supply of the process control application software, an Andritz dynamic process simulator

Brett Schug and Caelen Anderson, members SME, are business development manager-mining, Andritz and metallurgical superintendent, Haile Gold Mine, respectively and Carlos Cristoffanini and Sohail Nazari are senior consultant and mining business development manager, Andritz Automation, email Brett.Schug@andritz.com.

Figure 1
Haile processing plant flowsheet.

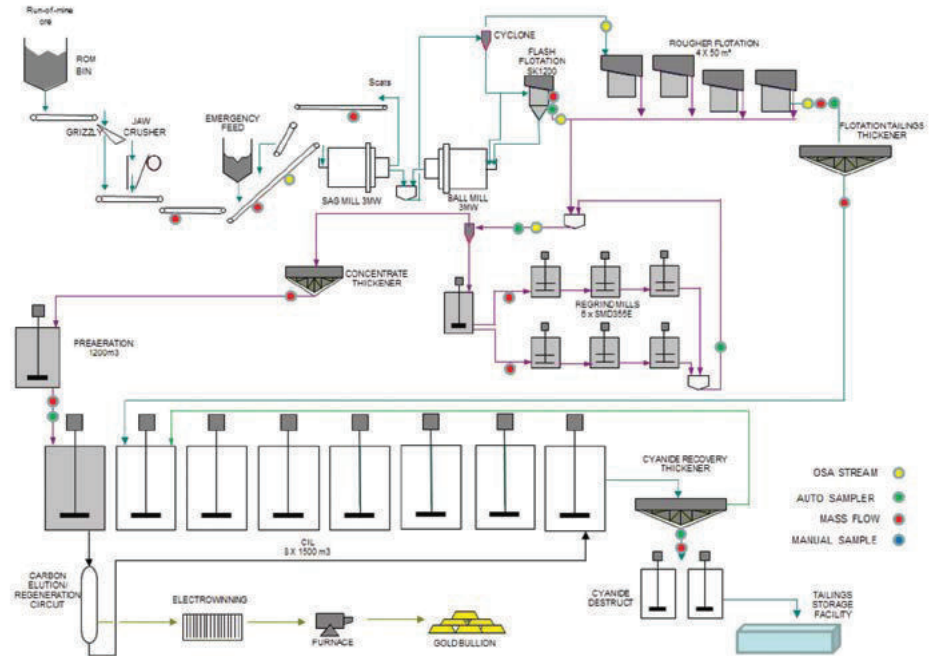

for operator training, and Andritz Advanced Control Expert (ACE) systems for the SAG mill, ball mill and rougher flotation areas. Since startup, Andritz has continued to provide services for the site, particularly related to programmable logic controller and human machine interface (HMI) equipment, programming and support, ACE system expansion, and the implementation of virtual instrumentation. The implementation of this new virtual instrumentation technology at Haile is consistent with Haile goals: increased automation, a change in the role of the operator from interactor to monitor and improved stability by removing human error.

The increasing use of simulation with IDEAS for metallurgical processing has been documented elsewhere, from Anderson and Nikkhah (2001), to Schug and McGarry (2016) and Tripathi et al. (2016). Parthasarathi, Szaruga and Szatkowski (2009) provide an overview of the capabilities of IDEAS at that time for both steady-state and dynamic modeling and for a wide range of applications in each phase of a project's life cycle. Notably, IDEAS performs steady-state and/or dynamic simulation for the entire process, including performing mass and energy balances, tracking the flow and concentration of components, compounds, elements and chemical species in multiple phases and handling particle size distribution. Nees and Gamarano (2011) describe the creation of a "virtual process plant" — an accurate representation of the planned process plant in terms of metallurgy, material movement, engineering design and process control. They describe the use of this virtual process plant for piping and instrumentation diagram validation, control system testing and operator training. The term virtual process plant can be related to a growing term in industry, digital twin.

The digital twin and virtual instruments

The term digital twin is being applied across a range of industries to describe a simulation of a real physical process, device or system, which is connected via sensors to its real counterpart.

The term digital twin was introduced in 2010 by NASA (Shafto et al., 2010), but an official definition of digital twin does not exist. Within the process industries, digital twin typically refers to a simulation model of some type that matches the operation of the plant and possibly includes a direct, real-time link to the plant. The uses of a digital twin are varied, and the use described in this paper is to provide virtual instruments for an operating process, where a similar physical instrument may or may not exist. Specifically, the virtual instruments for density and flow rate will be described.

The benefits of the virtual instruments at the Haile gold mine are described in general by Moore (2018). These virtual instruments are the first implementation of Andritz's real-time digital twin technology.

The problem, cause and solution

During implementation of an ACE advanced control package at Haile, Andritz engineers recognized the lower than desired signal quality of the density at the grinding area hydrocyclones supply line. The nuclear density transmitter had a limited range of accuracy and was subject to frequent recalibration. These characteristics can lead to problems when a control system uses density as a control loop input. For example, if a sudden decalibration of the density measurement occurs, then an unreasonable change would occur to the control loop's output signal and at the actuator. And, if the real density dropped below the bottom of the density instrument's range, then the control system

Figure 2

Sample IDEAS model of grinding area hydrocyclones supply.

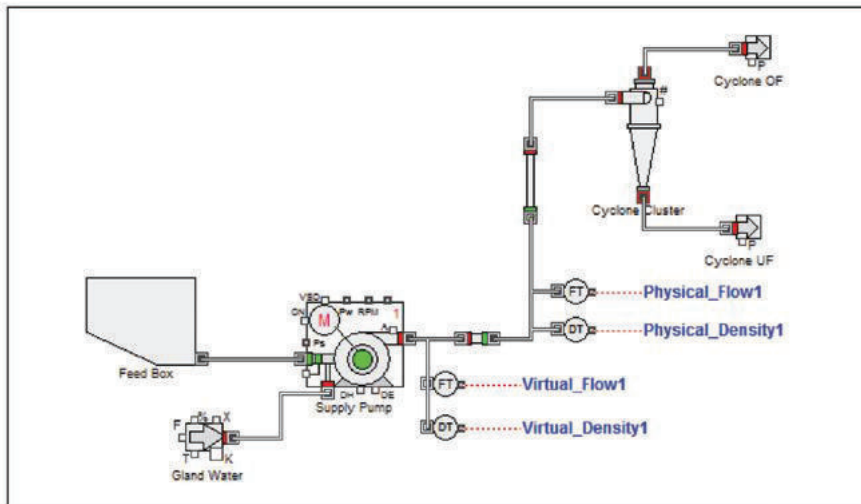

would be acting on an artificial, inaccurate input value. These types of issues lead some mines to perform weekly recalibration of their density instruments, while other mines may decide to abandon use of their density measurement.

These types of problems had been faced by the Andritz advanced process control engineers at various mines, and a solution had been theorized. The Haile location proved to be the perfect location to first test this new solution, since both an Andritz ACE installation and an IDEAS virtual process plant already existed for the process area, and since Haile is committed to automation and advanced technologies. The solution incorporates a small digital twin process area simulation model, connects to the process control system in real time to extract trusted transmitter values, and computes the process parameter based on this combination of known and trusted process and equipment information.

The virtual instrument inputs

The inputs for the virtual instruments are, as previously described, a small digital twin process area simulation model, and key process variables. For the simulation model, Haile already had a large operator training simulator model, from which the Andritz engineers extracted a portion that represented the grinding area hydrocyclones and their supply line. Similarly, they extracted a portion of the larger model at the tailing thickener underflow pump. Representative IDEAS process models for two areas are shown in Figs. 2 and 3. These diagrams also indicate where physical measurements exist, e.g. Physical_Density1, and where the virtual instrumentation is added, e.g. Virtual_Density1. It is important to note that the physical instruments are not necessary for their counterpart virtual instruments to be created.

Significant amounts of data are embedded within the IDEAS process models, including:

- Piping diameter, roughness, length, elevation change.
- Tank sizes, volumes, elevations, nozzle locations.
- Thickener sizes, volumes, elevations, nozzle locations and settling data.
- Hydrocyclones geometry, elevations, nozzle locations, and performance data.
- Pump curves and pump power curves.

The amount of data present in such a model allows the use of such models to perform hazard and operability (HAZOP) analysis, design capabilities investigation, control system verification and operator training, all in real time and with high fidelity. During such activities, the IDEAS model simulates the real, or planned, process. Andritz engineers realized that these types of models could be operated in a somewhat reversed manner to determine unknown process parameters, by using the models' embedded information and some trusted real-time information as extracted from the process control system.

For both the grinding and thickener areas, the trusted information extracted from the control system, on a real-time basis, includes tank level, pressure, pump speed and pump power. The data are

Figure 3

Sample IDEAS model of thickener and underflow.

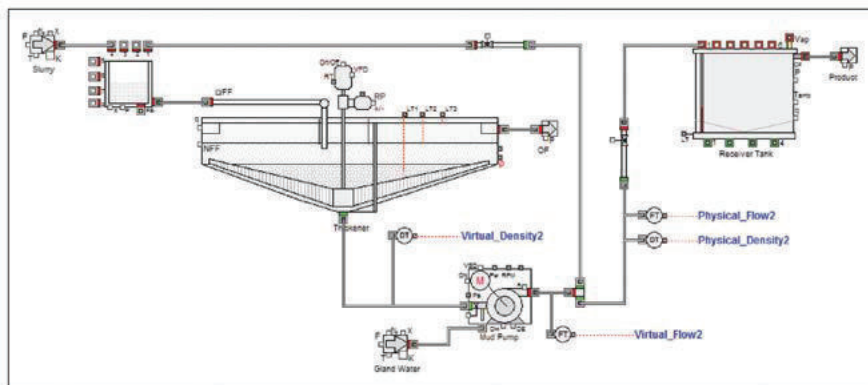
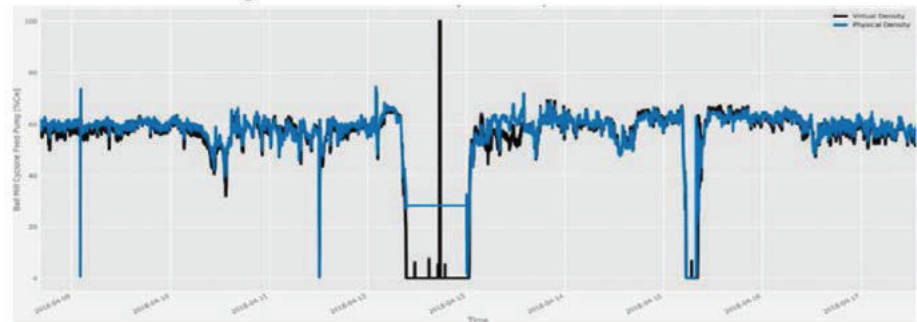

Figure 4**Virtual (black) and physical (blue) slurry density at hydrocyclones feed.**

extracted from the control system using OPC. The IDEAS model then performs its calculations to determine the desired virtual instrument values. In the above diagrams, those values are the virtual density and virtual flow of the slurry.

Condition monitoring

In addition to calculating the virtual values for density and flow, the virtual instruments system includes conditional processing and fault detection logic. Where physical instruments exist for reference, the system can detect and issue a warning for various conditions, including pump impeller wear or sudden damage, pipe sanding and density meter decalibration.

Deviations between the physical and virtual instrument may occur either gradually or suddenly. Gradual deviations to both density and flow typically indicate wear. Sudden deviations to both density and flow may indicate impeller damage or some other sudden problem. If the flow values are in agreement, but there is deviation of the density values, then the densitometer may be decalibrated or at fault. If the density values are in agreement, but there is deviation of the flow values, then sanding may be the cause, or possibly the flow meter may be at fault.

Andritz has created additional tags in the control system to then receive the virtual instrument values, and additional fields in the HMI to display those values. Finally, the operator also has new capabilities to enable the control system to use the virtual instrument instead of the physical instrument for process control.

Results

The new virtual instruments at the Haile operation have proven highly effective, with the virtual instrument values matching the physical instrument under normal operating conditions, and showing better prediction under upset conditions. For both locations, the Haile operation has physical instruments present, which makes direct comparison between virtual and physical instrumentation possible, and also allows early detection of problems with the physical instrument.

For normal operation, Figs. 4 and 5 show high agreement between the virtual (black)

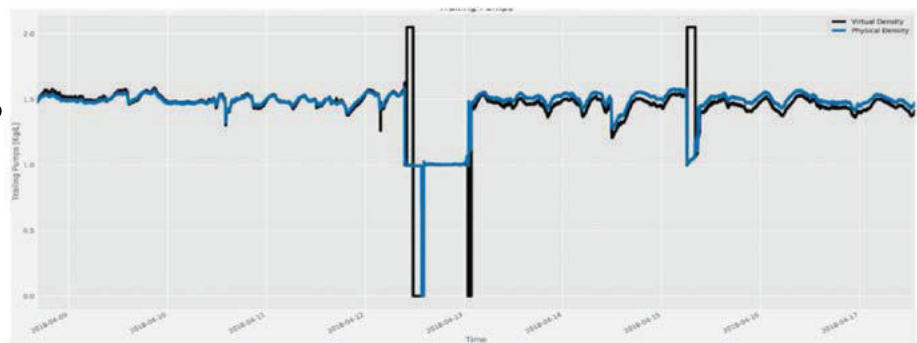
Figure 5**Virtual (black) and physical (blue) slurry density at thickener underflow.**

and physical (blue) density instruments over a 10-day period. The root mean square deviation (RMSD) for the hydrocyclones feed slurry density over the 10-day period was 2 percent.

The thickener underflow slurry density revealed a clear decalibration of the physical instrument at the center of the time period. The deviation on the right side of the plot is clear, whereas on the left side of the plot, the two values overlap one another. Before the decalibration, the RMSD for the thickener underflow slurry density was 1 percent. The sudden appearance of the deviation between the virtual and physical values can be detected by the virtual instrument data analysis and reported to the operator via the HMI.

In addition to the decalibration of a physical density transmitter, as shown in Fig. 5, the virtual instrument system can detect other fault conditions, such as those mentioned earlier: pump impeller wear or sudden damage and pipe sanding. The virtual instrument can, in many cases, detect such problems much faster than they might otherwise be detected, leading to faster resolution of the problem and more efficient operation.

After seeing favorable results from the initial virtual instruments, Haile decided to have Andritz install additional virtual instruments for the grinding area hydrocyclones overflow and underflow density. These instruments extend

Figure 6

Virtual (black) and physical (blue) slurry solids at hydrocyclones feed.

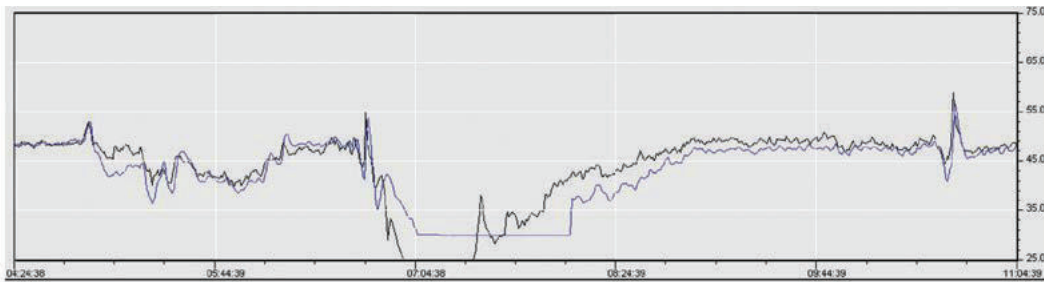

the initial grinding area IDEAS model present for the hydrocyclones feed virtual instruments. This additional work is in progress at the time of manuscript submission.

The speed of signal of the virtual instruments is another benefit that Haile has realized with the virtual instruments. For the slurry density measurements, the signal lag time, as seen from bump tests, is approximately 90 seconds for the physical instruments but only 30 seconds for the virtual instruments. At times, the speed difference is much larger, such as when the density increases from a value below its measurable range. Figure 6 reveals this speed benefit at the hydrocyclones feed density virtual instrument. Density is expressed as solids percent in this figure. Notice that the virtual signal, in black, leads the physical sensor signal, in blue. This characteristic is significantly more pronounced as the signal value drops to lower solids — near and below the measurable range, and then returns to the measureable range. The physical value, in blue, reaches its lower limit, of 30 percent, and stays at that point for an extended period of time. The virtual instrument provides a much faster and better signal in and near this region of operation.

Of greater difference is the response time of the new cyclone overflow and underflow densities as compared to the manual measurement of those densities. Those densities are not measured automatically, but are calculated from manual sampling every hour. So

the operator with timely and useful feedback.

Additional examples of fault detection with the virtual instrument system are seen in Fig. 7, which spans 18 hours of operation. In Section A of Fig. 7, the physical instrument and virtual instrument begin together but diverge as the solids percent of the slurry goes to a low value. At very low densities (low solids percent), the transmitter does not provide reliable values, and gives a value of zero for three hours of operation. In section B, both values again coincide, until the density again goes to a low value, and the physical instrument again produces a zero value. In this section, the virtual instrument also reaches zero as the pump is shut down for four hours. Section C illustrates a sudden, large bias between the values and indicates partial sanding of the pipe following the shutdown. The physical value is the accurate value in this instance. The condition monitoring within the virtual instrument system detects the sanding issue and sends a warning to the operator.

Haile frequently encounters sanding at this location since the volumetric flow in this pipe is lower than the design condition. Therefore, the calculation of the virtual value at this location has been modified since Fig. 7 was created. The virtual instrument calculations for solids at this pipe includes the physical flow transmitter value as an input, and now provides an accurate solids percent during sanding, while still providing a sanding condition warning to the operator.

Slurry density measurements are influenced by the flow rate through the measurement device. Figure 8 illustrates an increase in flow and a large increase in the physical solids measurement, in blue, at the hydrocyclones feed pipe. The actual solids would be expected to decrease slightly in this case,

Figure 7

Virtual (pink) and physical (blue) slurry solids and fault detection.

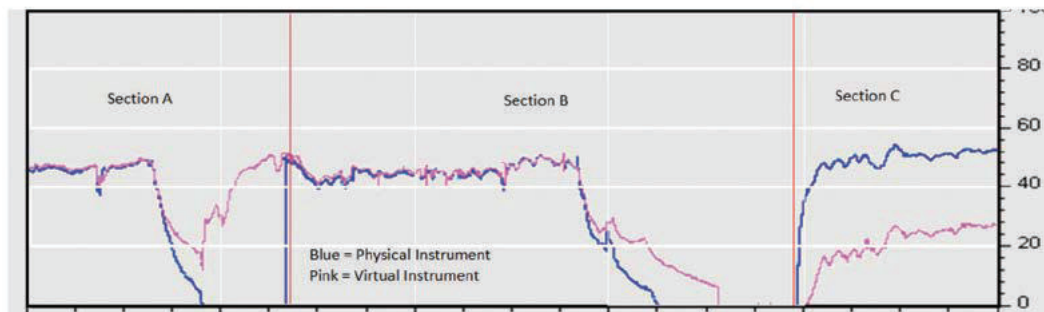
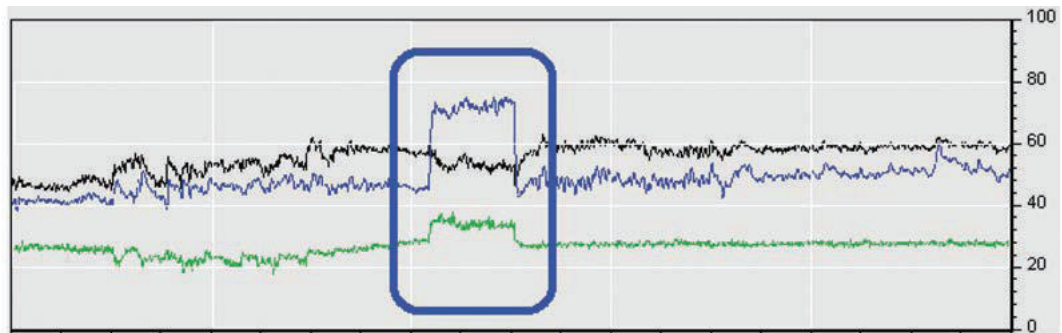

Figure 8

Virtual (black) and physical (blue) slurry solids with flow (green) change impact.



as the dilution water would likely increase to counteract a drop in the feed sump level. The (black) virtual instrument does display a slight decrease. Proper accommodation of the flow rate change for the physical instrument may be possible. But for the virtual instrument, no such accommodation is ever needed. The virtual instrument will function properly over the entire possible range of flow that might occur at the densitometer. The virtual instrument will even function properly for flow and other parameter values that have not yet occurred.

Physical and virtual instrumentation reliability and maintenance

The reliability of the virtual instruments at Haile has been excellent. The virtual instrument for density on the hydrocyclones feed line operated for more than 120 days with only a few minutes of downtime due to communication issues. The nuclear density device requires on average one recalibration per month, while the virtual instrument had no need for recalibration. Under the current virtual instrument algorithm, deviations between the physical and virtual density instruments have been resolved by recalibration of the physical device.

Equipment in any mining environment will need repair and replacement over time. Density meters will need calibration. Virtual instruments do not require calibration. The trusted transmitters that provide input values to the virtual instruments will need attention, just as they would without the virtual instrument. The other portion of the virtual instrument — the process model — will need to be adjusted if there are changes to the related process equipment. Some examples would be: changing the impeller size for the hydrocyclones feed pump, or changing the location of the pressure transmitter on that process line. And with any virtual system, computer hardware and software have a finite life.

Conclusions

The Haile gold mine has implemented Virtual Instrument technology by Andritz at its grinding area hydrocyclones and at its tailing thickener underflow pump. Results in both areas have been favorable. The

virtual instruments are more accurate and more reliable than physical instruments, perform self-diagnosis of problems with the physical instrument and process, and provide appropriate alarms to the operator. The virtual instrument values are available for, and have been used as, control system inputs. Virtual instruments for density have been added at the hydrocyclones overflow and underflow — a location that promises fast feedback to the operators as opposed to hourly manual sampling. Additional virtual instrument locations will be considered as Haile continues to increase the level of automation and improve the stability of the processing plant. ■

Acknowledgment

The authors wish to thank OceanaGold for permission to publish operational information and results in this paper, and for the support provided in the development of this new technology.

References

- Nikkah, K. and Anderson, C., 2001, Role of simulation software in design and operation of metallurgical plants: a case study. Presented at SME Annual Meeting, Denver, CO.
- Schug, B., and McGarry, M. (2016), "Utilizing and Operator Training Simulator on a New Copper Concentrator in Peru," SME conference, Phoenix, AZ.
- Tripathi, A., Jara, M.I., Carvajal, C., and Gomez Araya, F. (2016), "A Real-Time Dynamic Simulation of Selective Molybdenum Flotation, Thickening and Filtering Process," SME conference, Phoenix, AZ.
- Parthasarathi, P., Szaruga, V., and Szatkowski, M. (2009), "Benefits of Dynamic Simulation for Mineral Industry," Recent Advances in Mineral Processing Plant Design, pp. 84-92.
- Nees, M., and Gamarano, T., (2011), "The use of advanced simulation software for the development of the Virtual Process Plant," Procemin 2011, Santiago, Chile.
- M. Shafto, M., Conroy, M., Doyle, R., Glaessgen, E., Kemp, C., LeMoigne, J., and Wang, L., "Draft modeling, simulation, information technology & processing roadmap," Technology Area, vol. 11, 2010.
- Moore, E. (2018), "How to simulate an entire operation before production," *CIM Magazine*, Vol. 13, No. 6, pp. 46-51.